

Wall valve clockwise closing cold 1/2" - Chrome





CL.1

36 607 741



- without rosette
- handle Ø 60mm
- with cold marking
- head part with cut-to-length spindle and sleeve

Fits: CL.1, CYO

	Chrome	36 607 741-00
	Brushed Platinum	36 607 741-06
	Dark Chrome	36 607 741-19
	Brushed Durabronze (23kt Gold)	36 607 741-28
	Matte Black	36 607 741-33
	Brushed Champagne (22kt Gold)	36 607 741-46
	Champagne (22kt Gold)	36 607 741-47
	Brushed Dark Platinum	36 607 741-99

Required miscellaneous



- Wall valve 1/2" -** 35 607 970 90
- min. recess depth 85 mm
 - max. recess depth 145 mm

36 607 741

mm [inches]

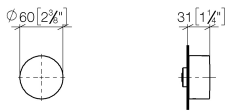

Certificates

DVGW_DW-
6501DN0116.

LGA_38107.

IAPMO_4976 (1).

LGA_29931.

WRAS_2010066.

LGA_29932.

36 607 741

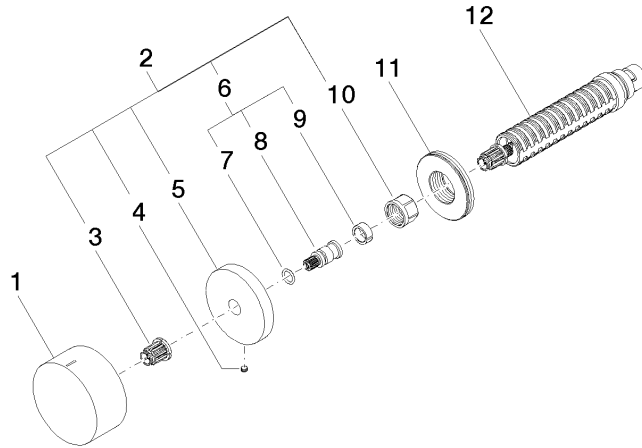

Spare parts list

No.	Item Number	Name	Quantity used	Delivery time
1	09 20 74 020-00	handle (cold)	1	10
2	04 27 74 004 00-00	rosette	1	10
3	90 12 12 002 00 90	fixing cap	1	2
4	09 31 11 055 90	pin	1	2
5	09 27 74 004-00	rosette	1	10
6	04 29 06 020 00-00	spindle	1	10
7	90 14 10 060 00 90	seal	1	2
8	09 29 06 020-00	spindle	1	10
9	90 14 15 020 03 90	ring	1	2
10	90 23 30 023 00 90	nut	1	2
11	09 30 01 107 90	sleeve	1	2
12	90 90 03 143 00 90	top	1	2